

Article number: 20145B182SW

Description: E+G Flanged Connector GN145-B18-2-SW

Measures

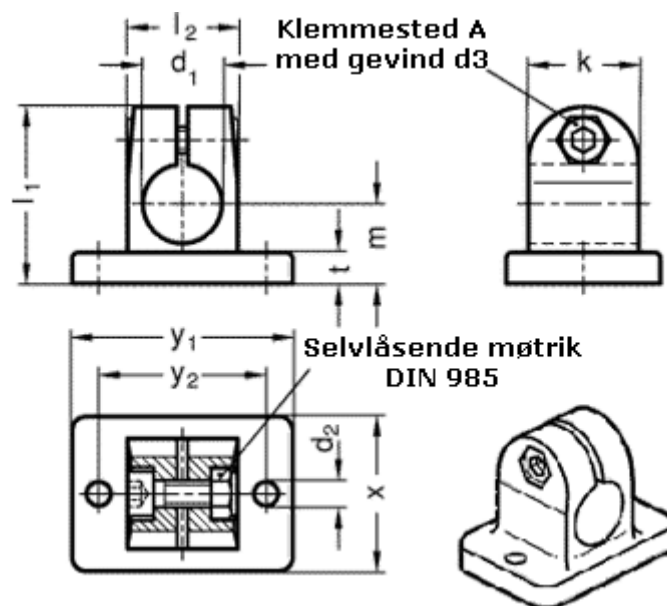

Adjustable clamp lever = GN 911-M 6-22 have to be ordred separately

d1	= B18
d2	= 5.5
d3	= M6
k	= 25
l1	= 40
l2	= 25
m	= 18

t	= 7
x	= 35
y1	= 50
y2	= 38